



Technische fiche SPT4000/BTE



Merk	EREA
Artikel nummer	SPT4000/BTE
EAN-code Barcode	5414503099150
Code	1710
Producttype	Driefasen scheidingstransfo
Spanning primair	3x 230V Δ -- 3x 400V Y+N
Spanning Secundair	3 x 230V Δ -- 3x 400V Y+N
Vermogen	4 000 VA
Normen	EN 61558-2-4

Algemene eigenschappen

Toepassing	Voor industriële toepassingen	Max omgevings-temperatuur ta	40 °C
Beschermingsklasse	Voorbereid voor beschermingsklasse I	Temperatuurklasse van de trafo	F
IP graad	IP00	Afwerking	Onder vacuüm en onder druk geïmpregneerd

Elektrische eigenschappen

Frequentie	50-60 Hz	Rendement	96,3 %
Po	44 W	Pcu	108 W
Diëlektrische vastheid	4500 Vac	Isolati weerstand	200 MΩ
Diëlektrische vastheid tov de massa	2500 Vac	Specifieke eigenschappen	Wikkelingen niet gekoppeld
Spanningsval (dU%)	4,7 %	Kortsluitspanning (Ucc %)	-
Aanbevolen zekering PRI	D16A / C32A (3x230V Δ) D10A/C20A (3x400V Y+N)	Aanbevolen zekering SEC	C10A (3x230V Δ) C6A (3x400V Y+N)

Mechanische eigenschappen

Aansluiting primair	Schroefklemmen 4 mm ²	Behuizing IP20	K20BTE/030
Aansluiting secundair	Schroefklemmen 4 mm ²	Behuizing IP23	K23BTE/030
Bevestiging	L-profielen met bevestigingsgaten	Behuizing IP44	K44BTE/030

Beschermkap

Afmetingen/gewicht

Afmetingen AxBxC	360x150x310 mm
Afmeting D	240 mm
Afmeting E	120 mm
Afmeting Φ	11 mm
Gewicht	36 kg

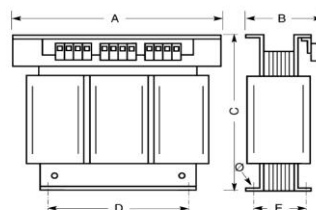



Aansluitschema SPT4000/BTE

230V Δ → 230V Δ

230V Δ → 400V Y+N

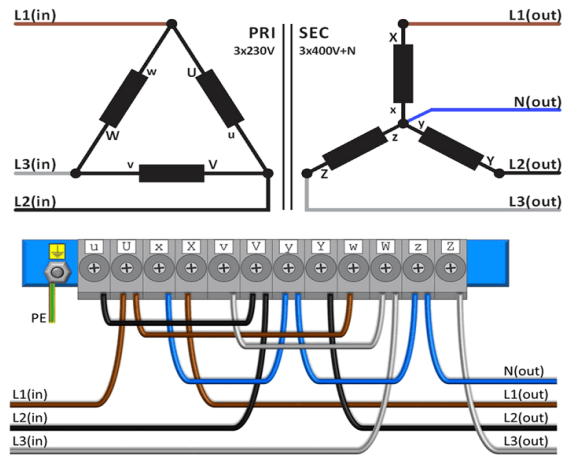
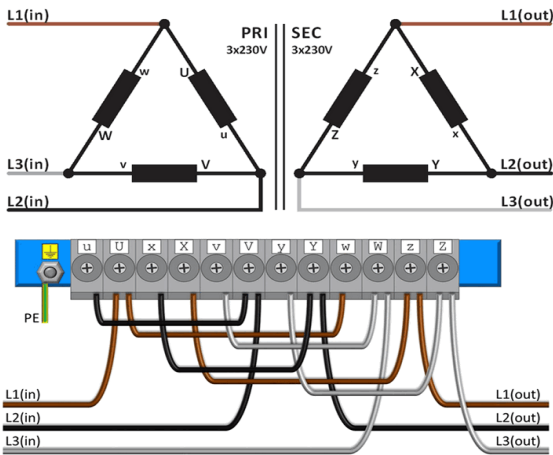

400V Y+N → 230V Δ

400V Y+N → 400V Y+N

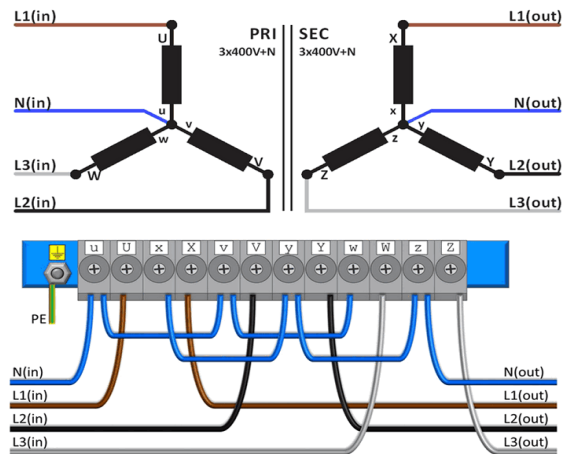
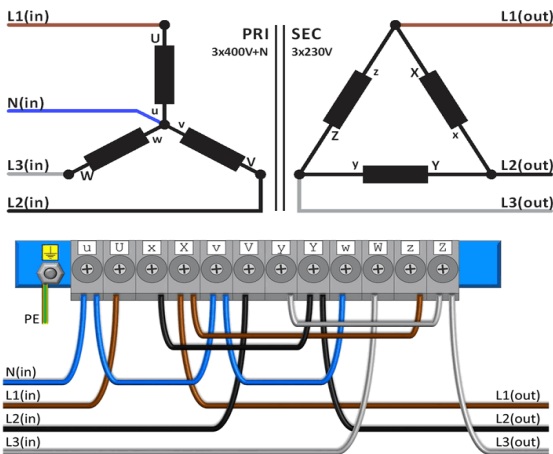



Accessoires SPT4000/BTE

IP20 beschermingskast

K20BTE/030



IP23 beschermingskast

K23BTE/030



Trillingsdemper

(4 stuks nodig per transfo)

Silent block 50

