



Technical datasheet SPT4000/BTE



Brand	EREA
Article Number	SPT4000/BTE
EAN-code Barcode	5414503099150
Code	1710
Product type	Three-phase separating transformer
Primary Voltage	3x 230V Δ -- 3x 400V Y+N
Secondary Voltage	3 x 230V Δ -- 3x 400V Y+N
Power	4 000 VA
Standards	EN 61558-2-4

General properties

Applications	For industrial applications	Maximum ambient temperature ta	40 °C
Protection class	Prepared for protection class I	Temperature class transfo	F
Degree of protection	IP00	Finishing	Vacuum- and pressure- varnish impregnated

Electrical properties

Frequency	50-60 Hz	Efficiency	96,3 %
Po	44 W	Pcu	108 W
Dielectric Strength	4500 Vac	Insulation resistance	200 MΩ
Dielectric strength referred to frame	2500 Vac	Specific property	Windings not connected
Voltage drop (dU%)	4,7 %	Short-circuit voltage (Ucc %)	-
Recommended fuse PRI	D16A / C32A (3x230V Δ) D10A/C20A (3x400V Y+N)	Recommended fuse SEC	C10A (3x230V Δ) C6A (3x400V Y+N)

Mechanical properties

Primary connection	Screw terminals 4 mm ²
Secondary connection	Screw terminals 4 mm ²
Fixation	Supports with fixing holes

Protection case

Housing IP20	K20BTE/030
Housing IP23	K23BTE/030
Housing IP44	K44BTE/030

Dimensions/weight

Dimensions AxBxC	360x150x310 mm
Dimension D	240 mm
Dimension E	120 mm
Dimension Φ	11 mm
Weight	36 kg

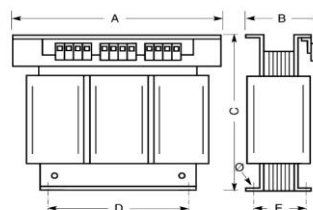



Connection diagram SPT4000/BTE

230V Δ → 230V Δ

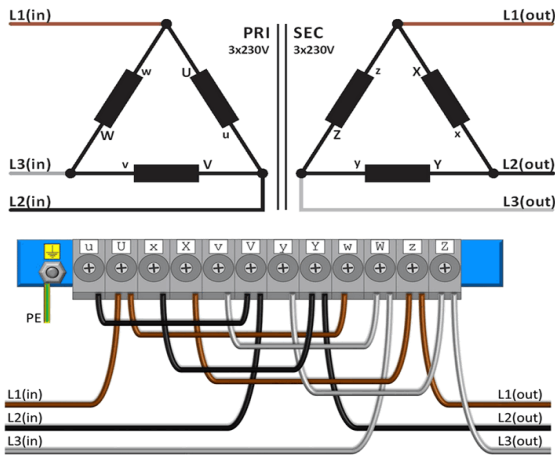

230V Δ → 400V Y+N

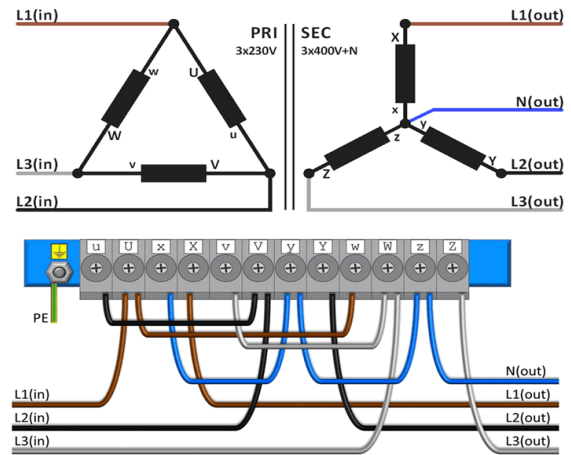

400V Y+N → 230V Δ

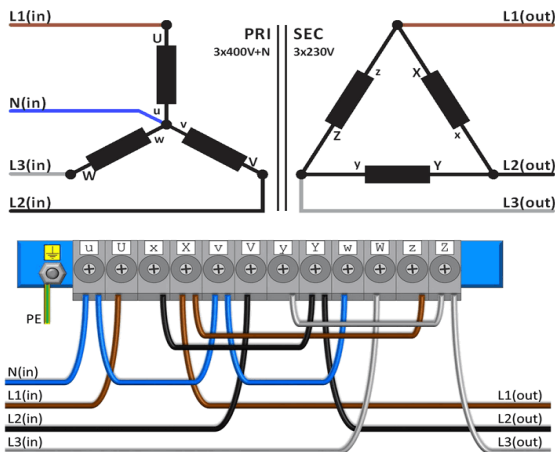

400V Y+N → 400V Y+N

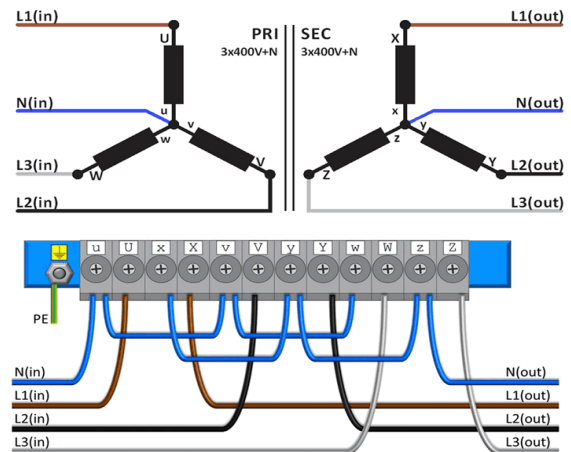



Accessories SPT4000/BTE

IP20 housing

K20BTE/030



IP23 housing

K23BTE/030



Vibration damper

(4 pieces needed per transformer)

Silent block 50

