



Technical datasheet

SPT2500



Brand	EREA
Article Number	SPT2500
EAN-code Barcode	5414503004703
Code	2709
Product type	Three-phase separating transformer
Primary Voltage	3x 230V Δ -- 3x 400V Y+N
Secondary Voltage	3 x 230V Δ -- 3x 400V Y+N
Power	2 500 VA
Standards	EN 61558-2-4 (EN 60742)

General properties

Applications	For industrial applications	Maximum ambient temperature ta	40 °C
Protection class	Prepared for protection class I	Temperature class transfo	B
Degree of protection	IP00	Finishing	Vacuum- and pressure- varnish impregnated

Electrical properties

Frequency	50-60 Hz	Efficiency	95 %
Po	45,5 W	Pcu	70 W
Dielectric Strength	4500 Vac	Insulation resistance	200 MΩ
Dielectric strength referred to frame	2500 Vac	Specific property	Windings not connected
Voltage drop (dU%)	2,8 %	Short-circuit voltage (Ucc %)	-
Recommended fuse PRI	D13A / C25A (3x230V Δ) D8A/C16A (3x400V Y+N)	Recommended fuse SEC	C8A (3x230V Δ) C4A (3x400V Y+N)

Mechanical properties

Primary connection	Screw terminals 2,5 mm ²
Secondary connection	Screw terminals 2,5 mm ²
Fixation	Supports with fixing holes

Protection case

Housing IP20	K20EI220
Housing IP23	K23EI220/002
Housing IP44	K44EI220/010

Dimensions/weight

Dimensions AxBxC	260x140x243 mm
Dimension D	100 mm
Dimension E	117 mm
Dimension Φ	11 mm
Weight	27 kg

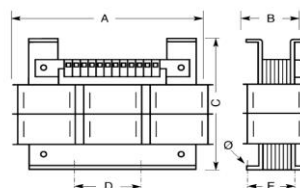



Connection diagram SPT2500

230V Δ → 230V Δ

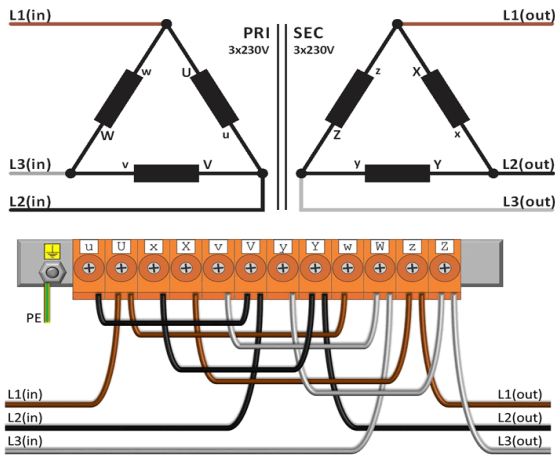

230V Δ → 400V Y+N

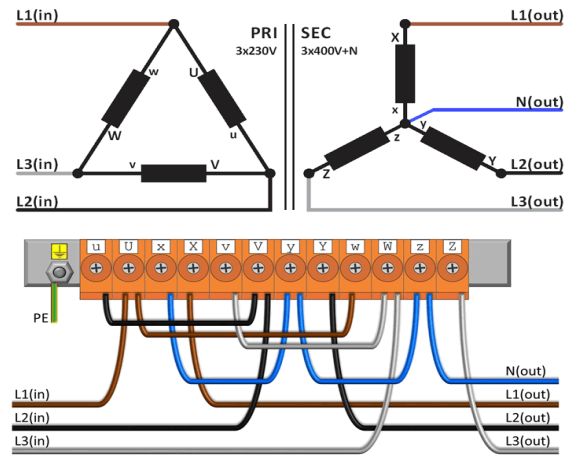

400V Y+N → 230V Δ

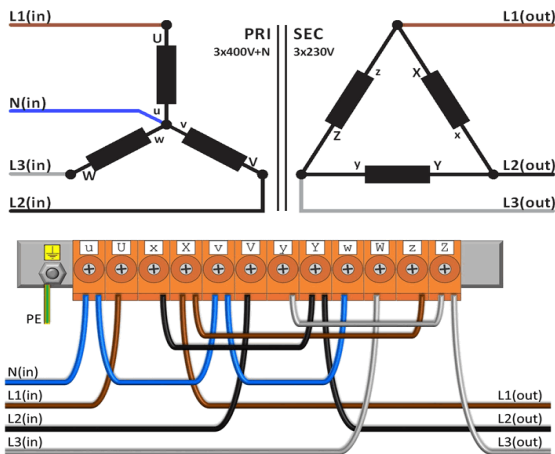

400V Y+N → 400V Y+N

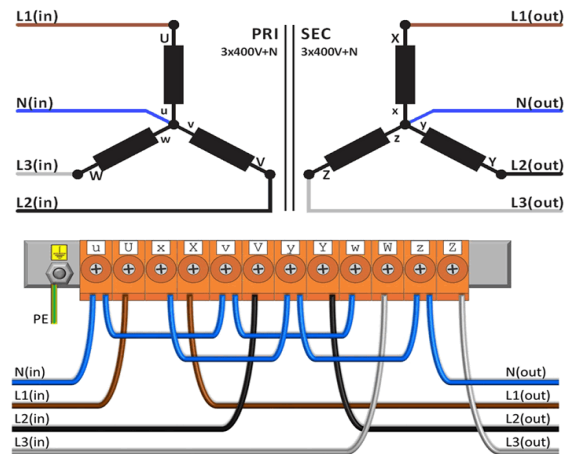



Accessories SPT2500

IP20 housing

K20EI220



IP23 housing

K23EI220/002



Vibration damper

(4 pieces needed per transformer)

Silent block 20



Inrush current limiter

IRC 230/400V-8A



rev. 13.11.2020