



Technical datasheet

IRC 230/400V-25A



Brand	EREA
Article Number	IRC 230/400V-25A
EAN-code Barcode	5414503004451
Code	2170
Product type	Inrush current limiter

Dimensions

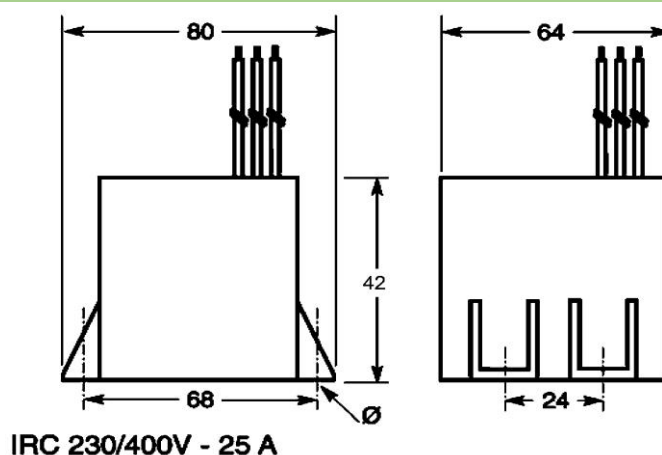

Connection diagram

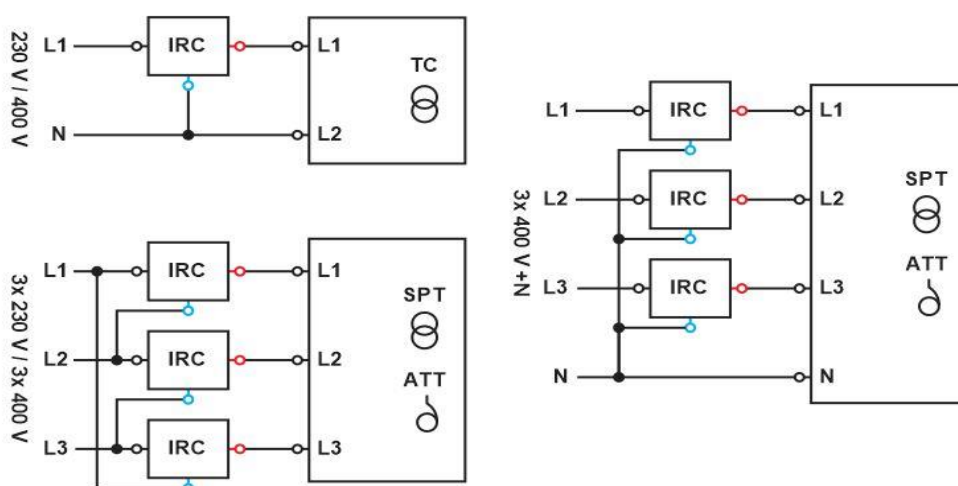

rev. 03.12.2020