



Technisches Datenblatt IRC 230/400V-16A



Marke	EREA
Artikelnummer	IRC 230/400V-16A
EAN-code Barcode	5414503004444
Code	2032
Produkttyp	Einschaltstrombegrenzer

Abmessungen

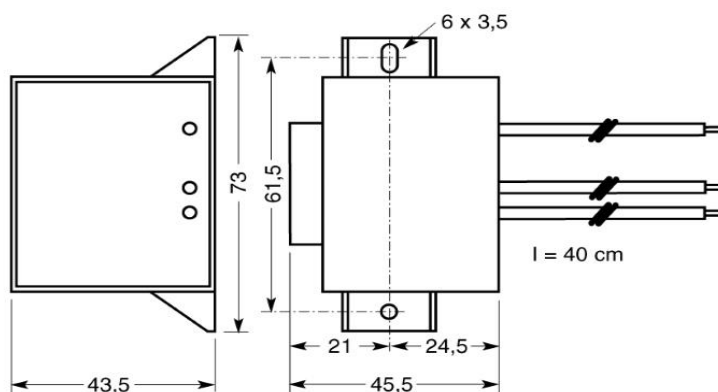

Schaltplan

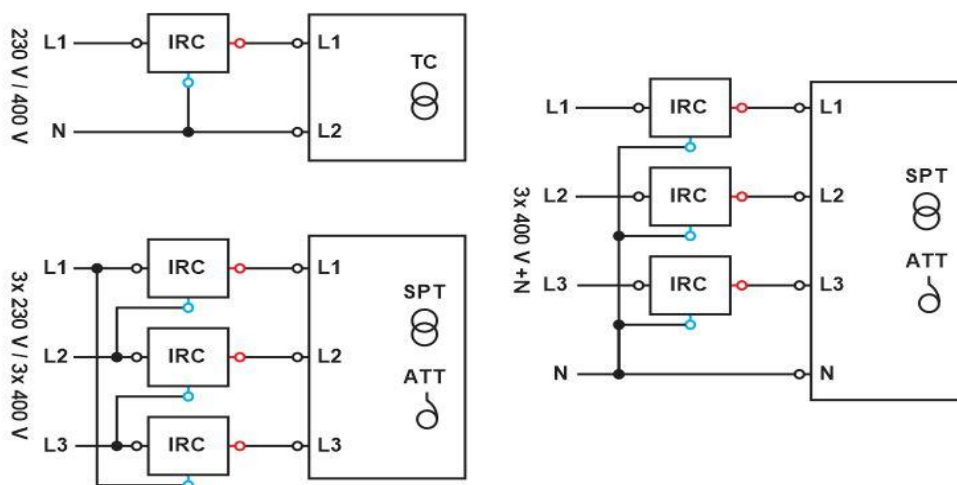

rev. 03.12.2020