



Technical datasheet

E 224TR3



Brand	EREA
Article Number	E 224TR3
EAN-code Barcode	5414503002907
Code	2630
Product type	Single-phase safety transformer
Primary Voltage	230V AC
Secondary Voltage	2 x 24V AC
Power	3 VA
Standards	EN 61558-2-6 EN 60742

General properties

Applications	Fitting to printed circuits	Maximum ambient temperature ta	40 °C
Protection class	II	Temperature class transfo	E
Degree of protection	IP00	Finishing	Vacuum-encapsulated with synthetic resin

Electrical properties

Frequency	50-60 Hz	Efficiency	62,36 %
Po	0,54 W	Pcu	1,22 W
Dielectric Strength	4000 Vac	Insulation resistance	200 MΩ

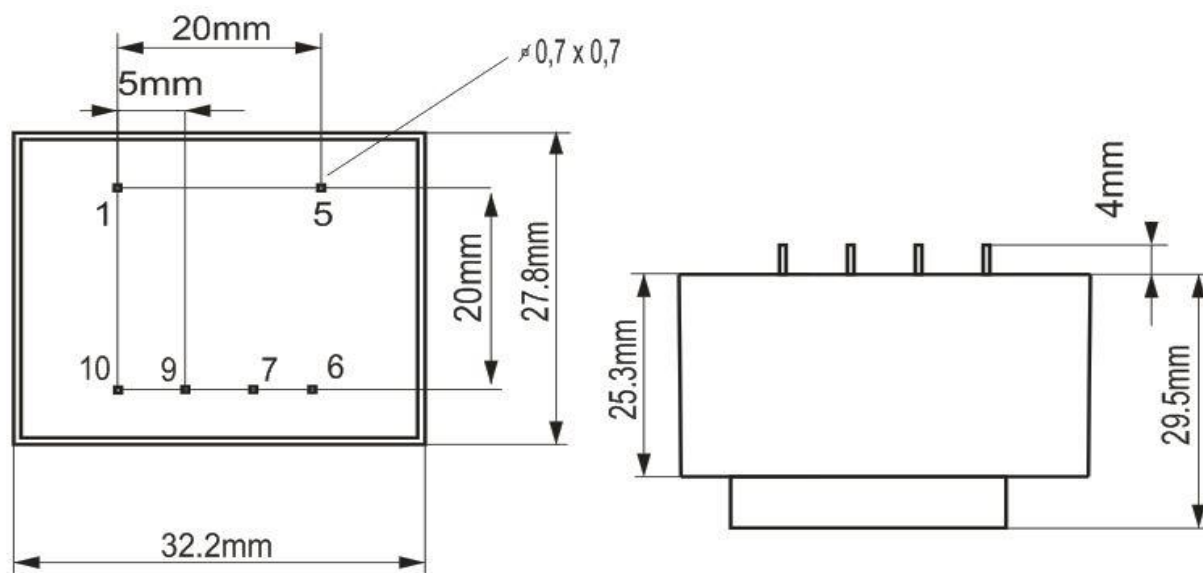

rev. 02.12.2020