



# Technical datasheet

## E 218TR40



Brand	EREA
Article Number	E 218TR40
EAN-code Barcode	5414503002723
Code	2624
Product type	Single-phase safety transformer
Primary Voltage	230V AC
Secondary Voltage	2 x 18V AC
Power	40 VA
Standards	EN 61558-2-6 EN 60742

### General properties

Applications	Fitting to printed circuits	Maximum ambient temperature ta	40 °C
Protection class	II	Temperature class transfo	E
Degree of protection	IP00	Finishing	Vacuum-encapsulated with synthetic resin

### Electrical properties

Frequency	50-60 Hz	Efficiency	84,84 %
Po	3,45 W	Pcu	4,3 W
Dielectric Strength	4000 Vac	Insulation resistance	200 MΩ

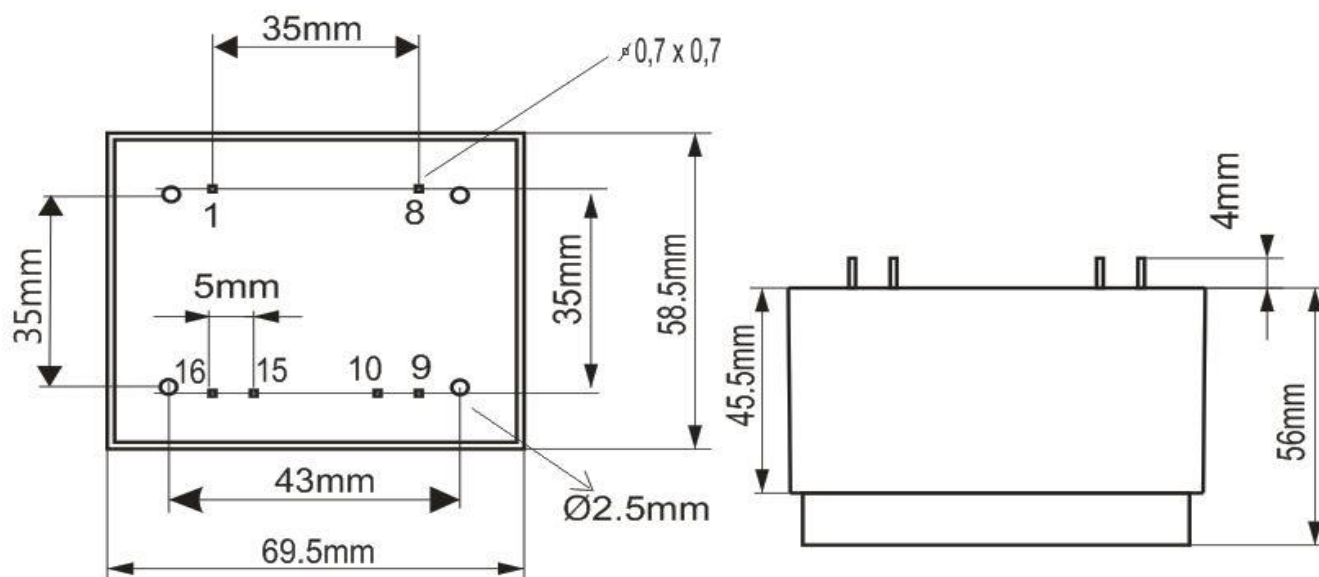

rev. 02.12.2020