

## Technische fiche E 212TR40



Merk	EREA
Artikel nummer	E 212TR40
EAN-code Barcode	5414503002402
Code	2608
Producttype	Eénfase veiligheidstransfo
Spanning primair	230V AC
Spanning Secundair	2 x 12V AC
Vermogen	40 VA
Normen	EN 61558-2-6   EN 60742

### Algemene eigenschappen

Toepassing	Montage op gedrukte schakelingen	Max omgevings-temperatuur ta	40 °C
Beschermingsklasse	II	Temperatuurklasse van de trafo	E
IP graad	IP00	Afwerking	Onder vacuüm ingegoten met kunsthars

### Elektrische eigenschappen

Frequentie	50-60 Hz	Rendement	85,1 %
Po	3,45 W	Pcu	4,15 W
Diëlektrische vastheid	4000 Vac	Isolatie weerstand	200 MΩ

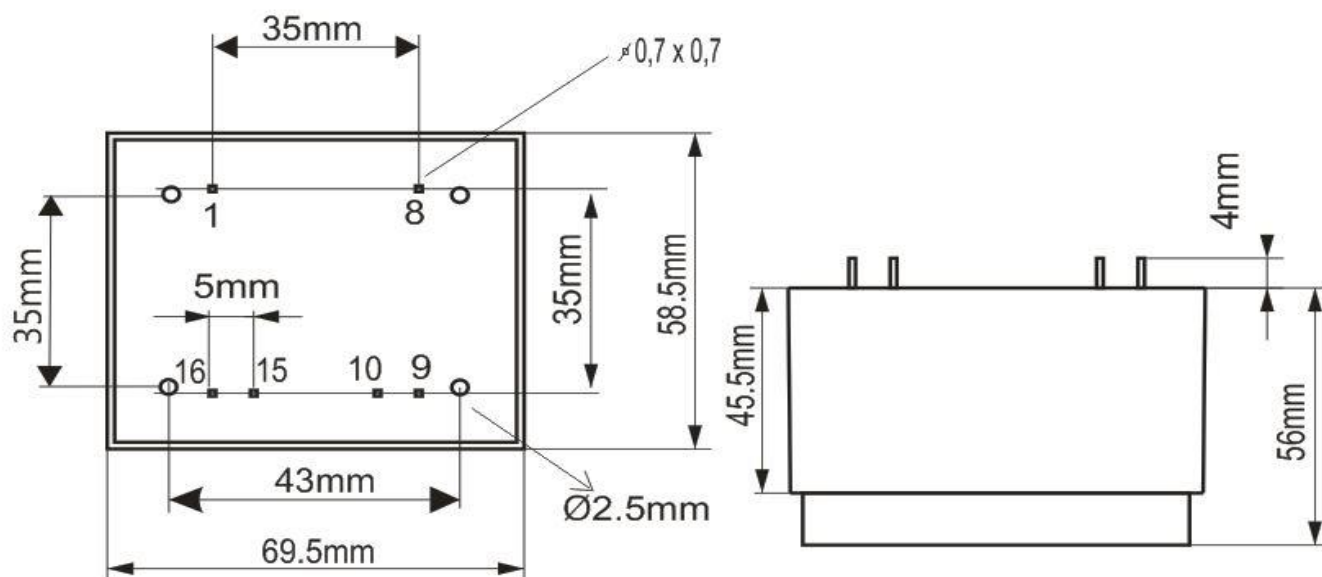

rev. 02.12.2020