



Technical datasheet

E 206TR25



Brand	EREA
Article Number	E 206TR25
EAN-code Barcode	5414503001825
Code	2588
Product type	Single-phase safety transformer
Primary Voltage	230V AC
Secondary Voltage	2 x 6V AC
Power	25 VA
Standards	EN 61558-2-6 EN 60742

General properties

Applications	Fitting to printed circuits	Maximum ambient temperature ta	40 °C
Protection class	II	Temperature class transfo	E
Degree of protection	IP00	Finishing	Vacuum-encapsulated with synthetic resin

Electrical properties

Frequency	50-60 Hz	Efficiency	80,31 %
Po	1,92 W	Pcu	4,67 W
Dielectric Strength	4000 Vac	Insulation resistance	200 MΩ

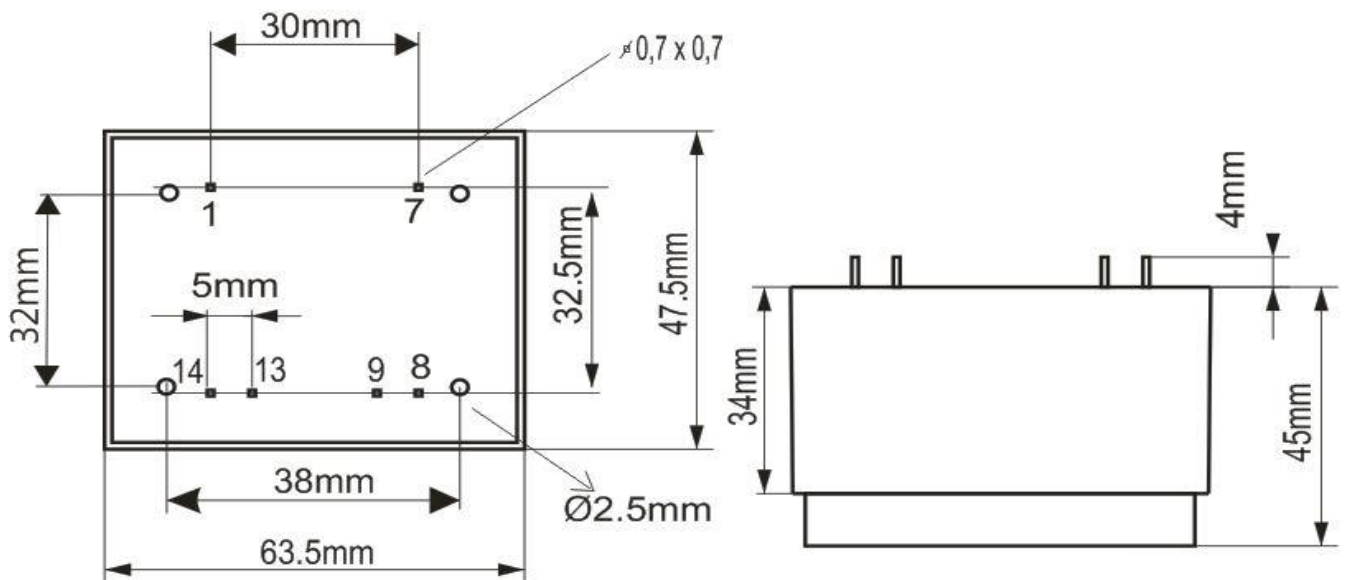

rev. 02.12.2020