



# Technical datasheet

## E 206TR10



Brand	EREA
Article Number	E 206TR10
EAN-code Barcode	5414503001764
Code	2585
Product type	Single-phase safety transformer
Primary Voltage	230V AC
Secondary Voltage	2 x 6V AC
Power	10 VA
Standards	EN 61558-2-6 EN 60742

### General properties

Applications	Fitting to printed circuits	Maximum ambient temperature ta	40 °C
Protection class	II	Temperature class transfo	E
Degree of protection	IP00	Finishing	Vacuum-encapsulated with synthetic resin

### Electrical properties

Frequency	50-60 Hz	Efficiency	75,3 %
Po	1,1 W	Pcu	2,54 W
Dielectric Strength	4000 Vac	Insulation resistance	200 MΩ

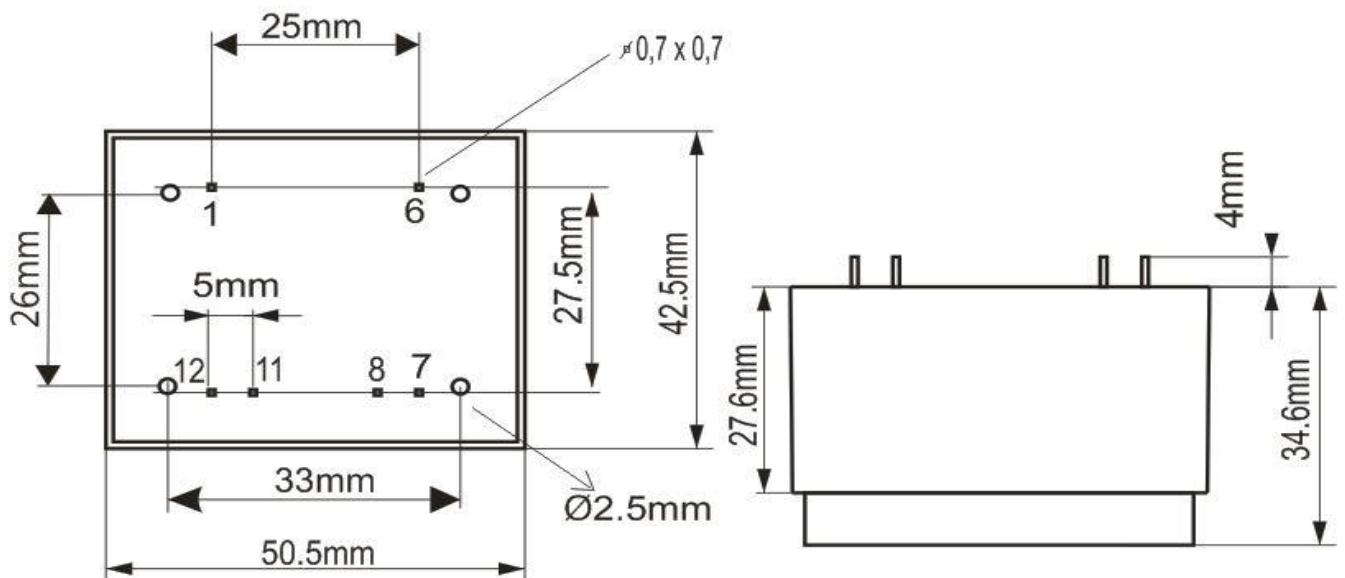

rev. 02.12.2020