



Technische fiche E 16TR7



Merk	EREA
Artikel nummer	E 16TR7
EAN-code Barcode	5414503006356
Code	2007
Producttype	Eénfase veiligheidstransfo
Spanning primair	230V AC
Spanning Secundair	2x 0-6-8V AC
Vermogen	6 VA
Normen	EN 61558-2-6 EN 60742

Algemene eigenschappen

Toepassing	Montage op gedrukte schakelingen	Max omgevings-temperatuur ta	40 °C
Beschermingsklasse	II	Temperatuurklasse van de trafo	E
IP graad	IP00	Afwerking	Onder vacuüm ingegoten met kunsthars

Elektrische eigenschappen

Frequentie	50-60 Hz	Rendement	74,12 %
Po	0,81 W	Pcu	1,64 W
Diëlektrische vastheid	4000 Vac	Isolatie weerstand	200 MΩ

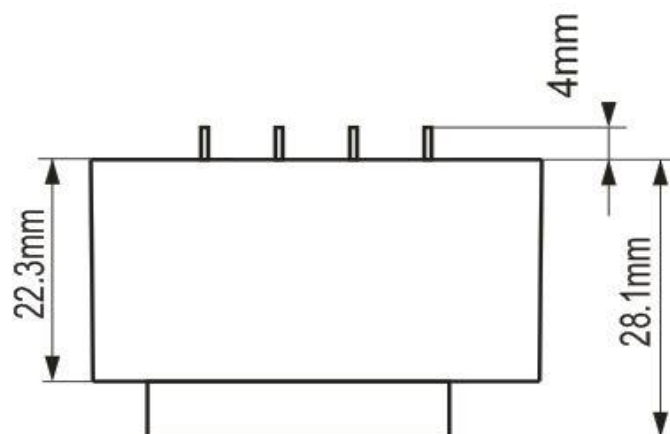
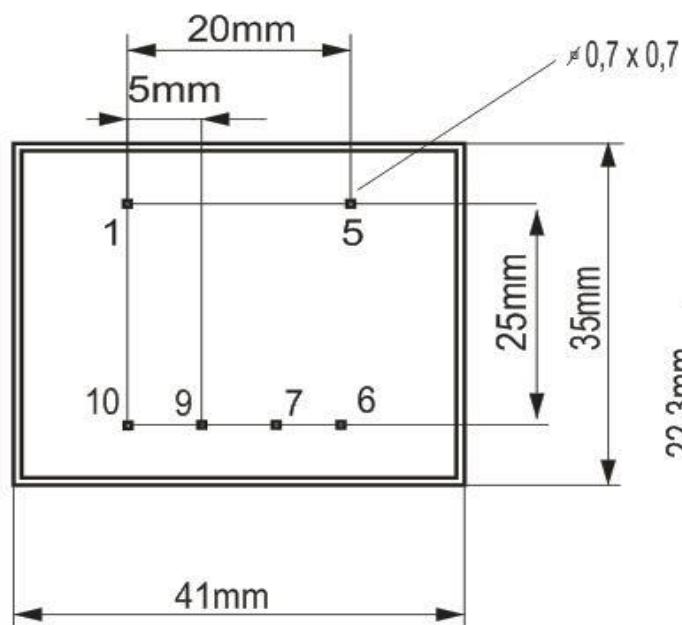

rev. 02.12.2020