



Technische fiche E 16TR10



Merk	EREA
Artikel nummer	E 16TR10
EAN-code Barcode	5414503006264
Code	2009
Producttype	Eénfase veiligheidstransfo
Spanning primair	230V AC
Spanning Secundair	2x 0-6-8V AC
Vermogen	10 VA
Normen	EN 61558-2-6 EN 60742

Algemene eigenschappen

Toepassing	Montage op gedrukte schakelingen	Max omgevings-temperatuur ta	40 °C
Beschermingsklasse	II	Temperatuurklasse van de trafo	E
IP graad	IP00	Afwerking	Onder vacuüm ingegoten met kunsthars

Elektrische eigenschappen

Frequentie	50-60 Hz	Rendement	76,33 %
Po	1,19 W	Pcu	2,22 W
Diëlektrische vastheid	4000 Vac	Isolati weerstand	200 MΩ

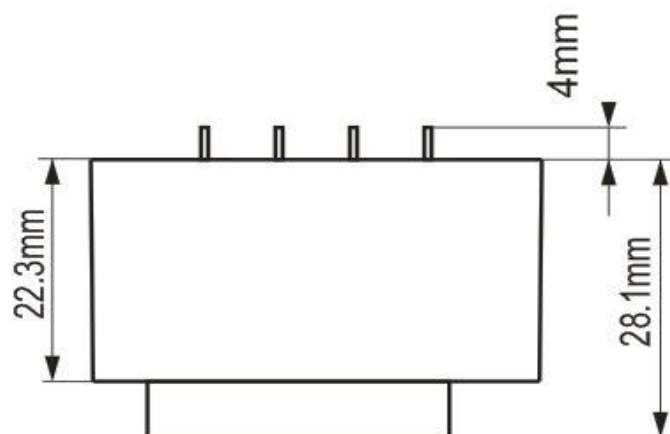
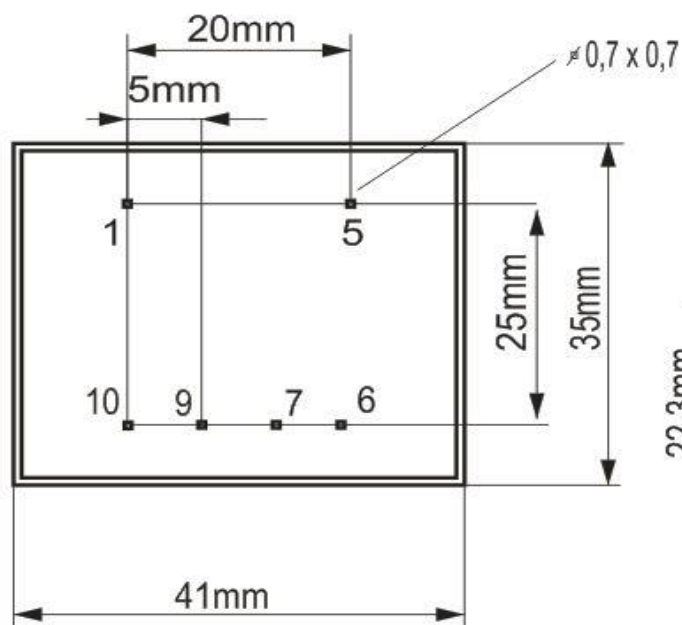

rev. 02.12.2020