



Technical datasheet

E 124TR2



Brand	EREA
Article Number	E 124TR2
EAN-code Barcode	5414503001313
Code	2576
Product type	Single-phase safety transformer
Primary Voltage	230V AC
Secondary Voltage	24V AC
Power	2 VA
Standards	EN 61558-2-6 EN 60742

General properties

Applications	Fitting to printed circuits	Maximum ambient temperature ta	40 °C
Protection class	II	Temperature class transfo	E
Degree of protection	IP00	Finishing	Vacuum-encapsulated with synthetic resin

Electrical properties

Frequency	50-60 Hz	Efficiency	54,86 %
Po	0,49 W	Pcu	1,25 W
Dielectric Strength	4000 Vac	Insulation resistance	200 MΩ

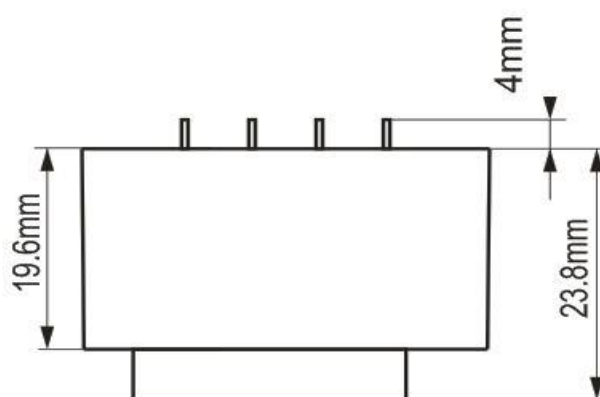
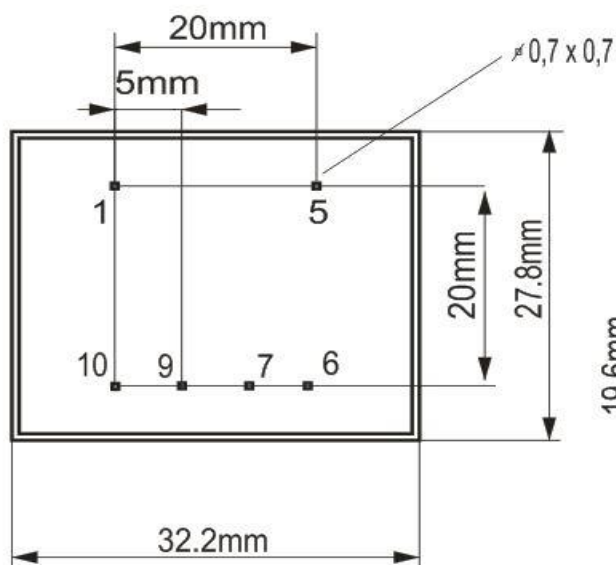

rev. 02.12.2020