



Technische fiche E 124TRO



Merk	EREA
Artikel nummer	E 124TRO
EAN-code Barcode	5414503001252
Code	2573
Producttype	Eénfase veiligheidstransfo
Spanning primair	230V AC
Spanning Secundair	24V AC
Vermogen	1 VA
Normen	EN 61558-2-6 EN 60742

Algemene eigenschappen

Toepassing	Montage op gedrukte schakelingen	Max omgevings-temperatuur ta	40 °C
Beschermingsklasse	II	Temperatuurklasse van de trafo	E
IP graad	IP00	Afwerking	Onder vacuüm ingegoten met kunsthars

Elektrische eigenschappen

Frequentie	50-60 Hz	Rendement	45,39 %
Po	0,46 W	Pcu	0,59 W
Diëlektrische vastheid	4000 Vac	Isolatie weerstand	200 MΩ

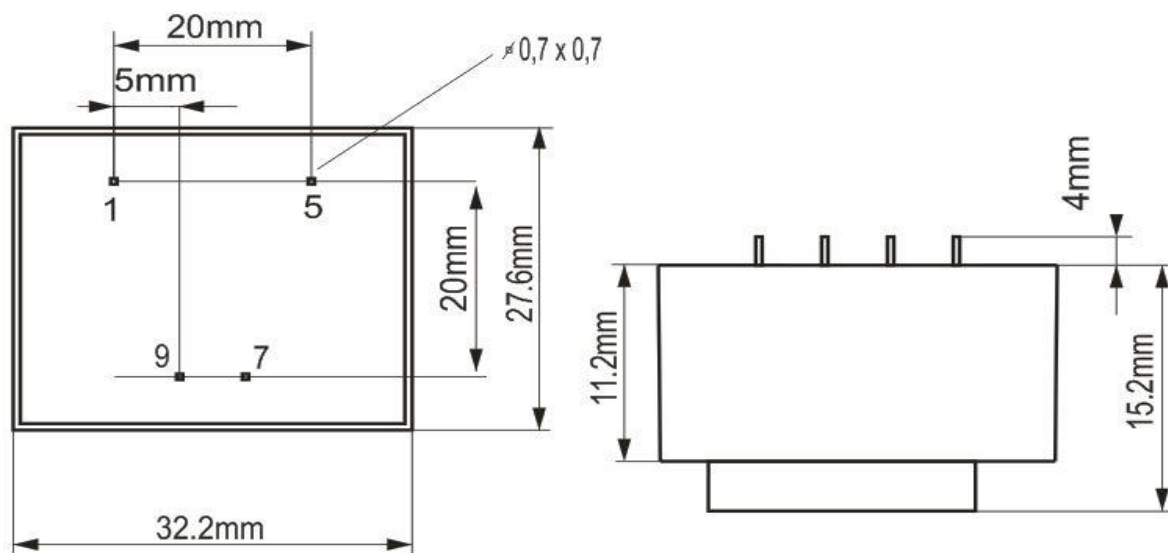

rev. 02.12.2020