

Technische fiche

E 115TR25



Merk	EREA
Artikel nummer	E 115TR25
EAN-code Barcode	5414503001016
Code	2559
Producttype	Eénfase veiligheidstransfo
Spanning primair	230V AC
Spanning Secundair	15V AC
Vermogen	25 VA
Normen	EN 61558-2-6 EN 60742

Algemene eigenschappen

Toepassing	Montage op gedrukte schakelingen	Max omgevings-temperatuur ta	40 °C
Beschermingsklasse	II	Temperatuurklasse van de trafo	E
IP graad	IP00	Afwerking	Onder vacuüm ingegoten met kunsthars

Elektrische eigenschappen

Frequentie	50-60 Hz	Rendement	80,21 %
Po	1,92 W	Pcu	4,71 W
Diëlektrische vastheid	4000 Vac	Isolatieweerstand	200 MΩ

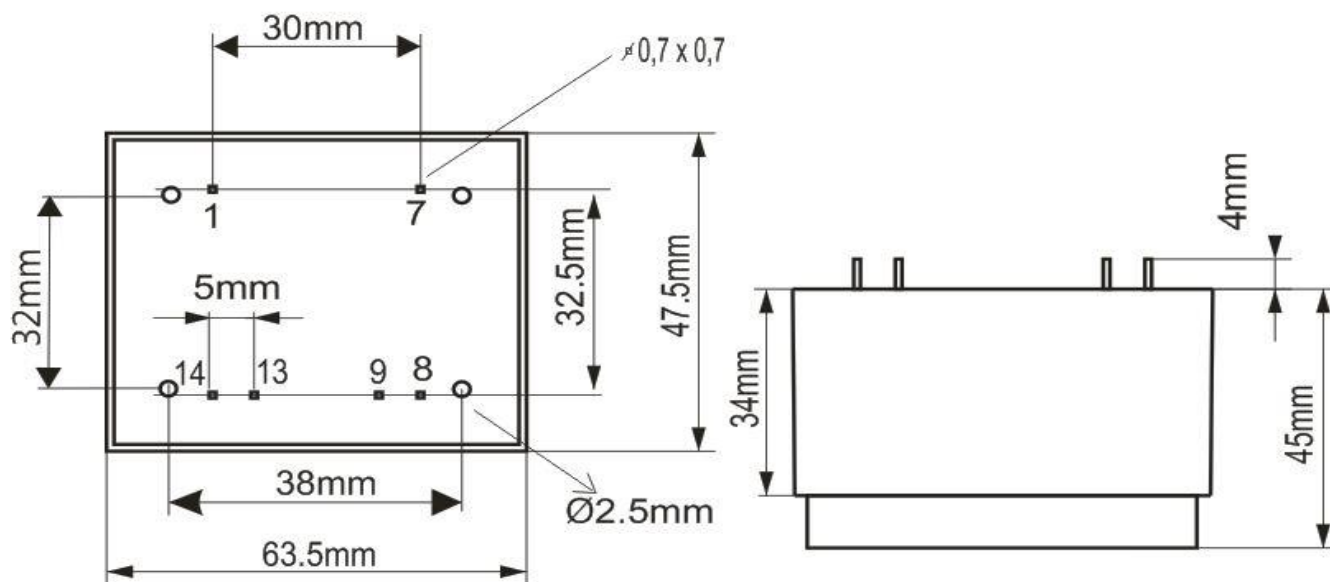

rev. 02.12.2020