



Technische fiche E 109TR5



Merk	EREA
Artikel nummer	E 109TR5
EAN-code Barcode	5414503000750
Code	2545
Producttype	Eénfase veiligheidstransfo
Spanning primair	230V AC
Spanning Secundair	9V AC
Vermogen	5 VA
Normen	EN 61558-2-6 EN 60742

Algemene eigenschappen

Toepassing	Montage op gedrukte schakelingen	Max omgevings-temperatuur ta	40 °C
Beschermingsklasse	II	Temperatuurklasse van de trafo	E
IP graad	IP00	Afwerking	Onder vacuüm ingegoten met kunsthars

Elektrische eigenschappen

Frequentie	50-60 Hz	Rendement	72,64 %
Po	0,83 W	Pcu	1,35 W
Diëlektrische vastheid	4000 Vac	Isolatieweerstand	200 MΩ

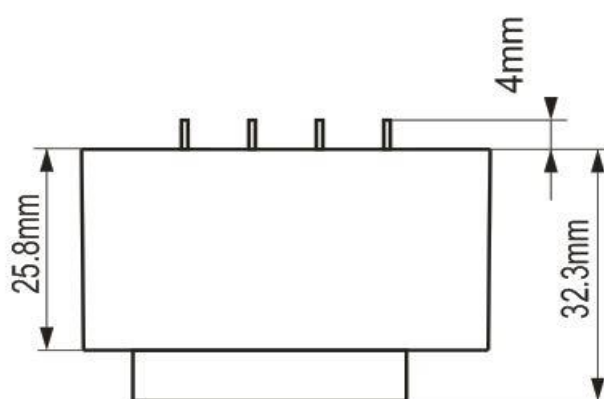
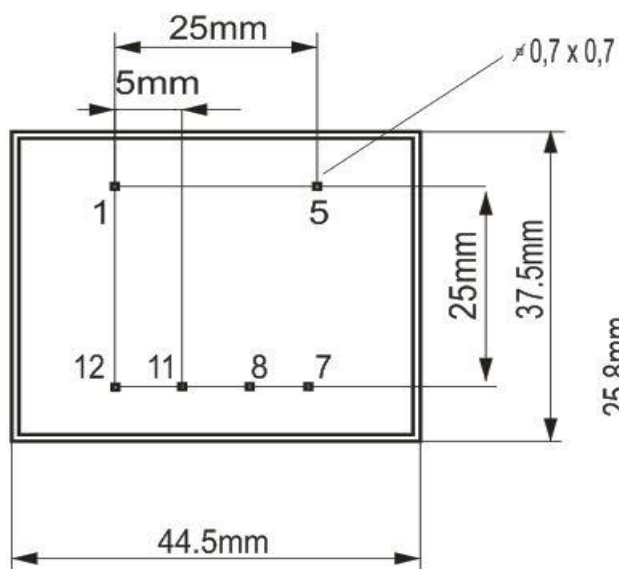

rev. 02.12.2020