



# Technical datasheet

## E 106TR4



Brand	EREA
Article Number	E 106TR4
EAN-code Barcode	5414503000590
Code	2535
Product type	Single-phase safety transformer
Primary Voltage	230V AC
Secondary Voltage	2 x 24V AC
Power	3 VA
Standards	EN 61558-2-6 EN 60742

### General properties

Applications	Fitting to printed circuits	Maximum ambient temperature ta	40 °C
Protection class	II	Temperature class transfo	E
Degree of protection	IP00	Finishing	Vacuum-encapsulated with synthetic resin

### Electrical properties

Frequency	50-60 Hz	Efficiency	67,6 %
Po	0,62 W	Pcu	1,15 W
Dielectric Strength	4000 Vac	Insulation resistance	200 MΩ

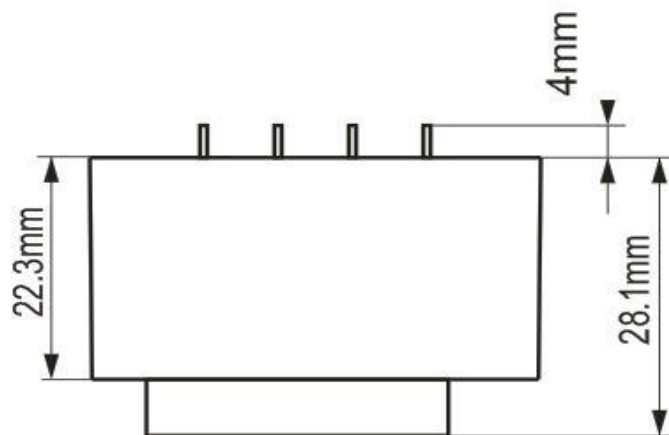
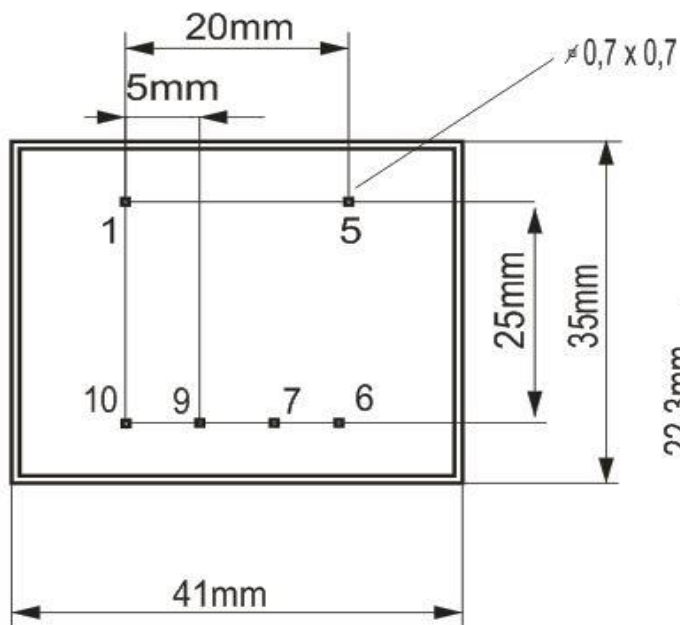

rev. 02.12.2020