



Technische fiche E 106TR3



Merk	EREA
Artikel nummer	E 106TR3
EAN-code Barcode	5414503000576
Code	2534
Producttype	Eénfase veiligheidstransfo
Spanning primair	230V AC
Spanning Secundair	6V AC
Vermogen	3 VA
Normen	EN 61558-2-6 EN 60742

Algemene eigenschappen

Toepassing	Montage op gedrukte schakelingen	Max omgevings-temperatuur ta	40 °C
Beschermingsklasse	II	Temperatuurklasse van de trafo	E
IP graad	IP00	Afwerking	Onder vacuüm ingegoten met kunsthars

Elektrische eigenschappen

Frequentie	50-60 Hz	Rendement	62,33 %
Po	0,54 W	Pcu	1,22 W
Diëlektrische vastheid	4000 Vac	Isolatie weerstand	200 MΩ

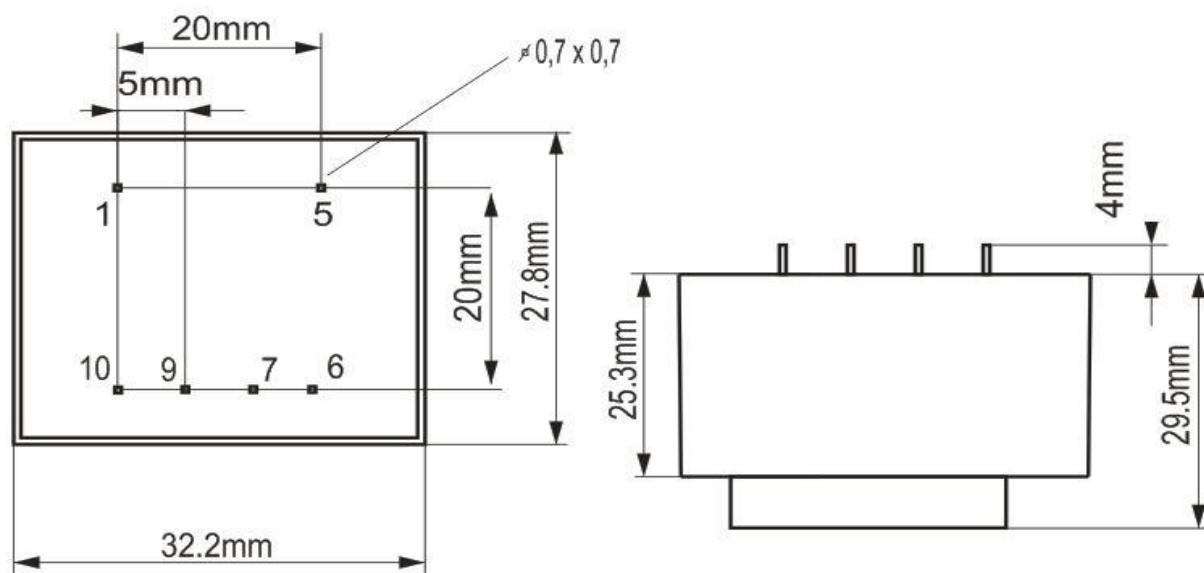

rev. 02.12.2020